

YSV20

Direct Actuated
15mm Micro Solenoid Valves

- 3/2- Direct Operation Type
- Manifold Mounting Type
- Orifice \varnothing 1.1mm

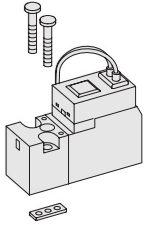

YSV20-DP-SD-***
M 1 2 3

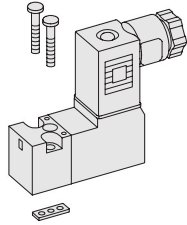

YSV20-DP-SC-CN1-***
M 1 2 3

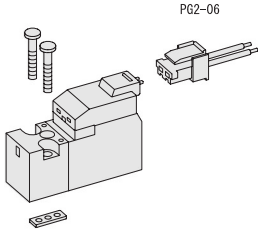

YSV20-DP-SM-***
M 1 2 3

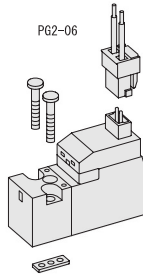

YSV20-DP-SL-***
M 1 2 3

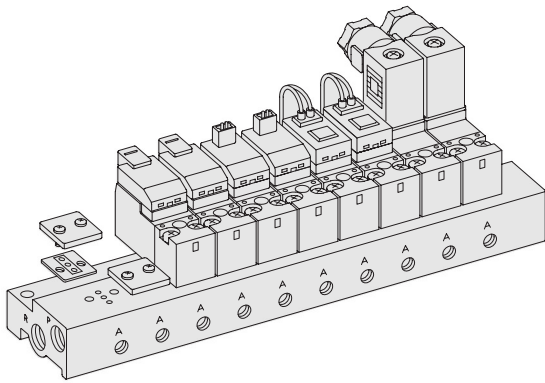

** : Voltage Selection

SPECIFICATION

ITEM	SERIES	FUNCTION
	YSV20	3/2-N.C
Fluids	Compressed Air & Inert Gases	
Pressure(bar)	0~8.0	
Orifice(mm)	P = \varnothing 1.1, R = \varnothing 1.5	
Ambient & Fluid Temp.	5~60°C (41~140°F)	
Response Time(5bar)	20ms or Less	
Max. Working Frequency	10c/sec	
Lubrication	Not Required(Use ISO VG32 #)	
Manual Override	Push Button	
Coil Insulation Class	F-Class or Equivalent	
Permissible Voltage Variation	\pm 10% of Rated Voltage	
Off Min. Residual Voltage	AC:20% or Less / DC:10% or Less	
Power Consumption	AC:3.5VA(60Hz) / DC:2.5W	

Transition Capacity Graph

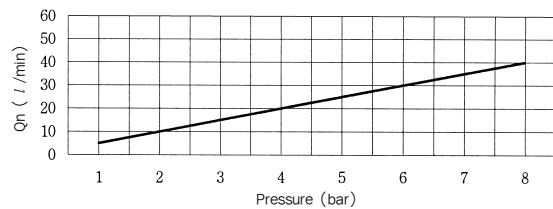

The Material of Parts

- Pilot Parts : Glass Filled Nylon
- Spring : Stainless
- Seals : NBR
- Armature : Stainless Steel
- Indicator Cap : Polycarbonate
- Lead Wire : AWG-no.24
- Lead Wire Packing : Viton

Plug Connector With Clip

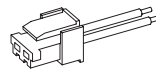

Ordering Code
PG2-06 (L : 600mm)
PG2-10 (L : 1,000mm)

Blanking Plate (Material : STS304)

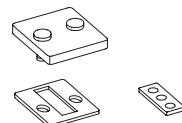

Ordering Code
YMF20 - BLK

* The specification on each item can be amended without any prenotice to improve a performance.
* The specification on each item can be different from actual specification.

ORDERING NO.

YSV2 0 - D P - SC - CN1 - D4

Valve Series	Function	Pilot Source	Manual Operator	Solenoid Coil Type	Connector Type	Voltage
YSV2 : Solenoid Valve	0 3/2 Normally Closed Spring Return	D Direct Operated	P Push Non-Locking	0 None SC 3 Pin Connector Coil SG Grommet /Flying Leads SD Grommet /Flying Leads With LED SL 90 Degree Plug-in Wire Assembly with LED SM 180 Degree Plug-in Wire Assembly with LED	0 None CN1 Normal Connector CD1 Connector With LED CZ1 Connector With LED & Surge Suppressor	0 None A2 AC 220V A1 AC 110V D4 DC 24V D2 DC 12V

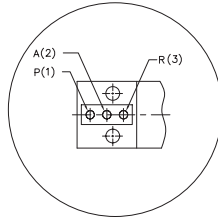
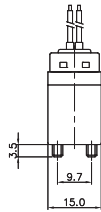
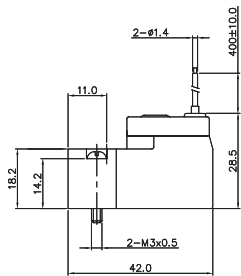
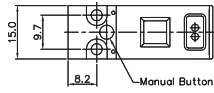
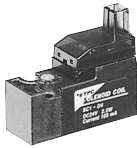
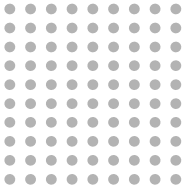

Normally Closed Type

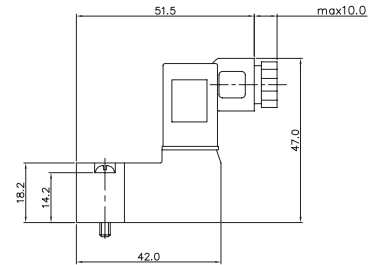

YSV20-DP-SC-CN1-***
Normally Closed

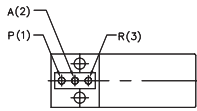
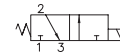

YSV20-DP-SD-***
Normally Closed

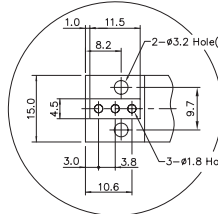
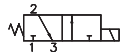

Sealing Area

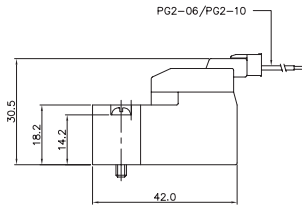

YSV20-DP-SM-***
Normally Closed

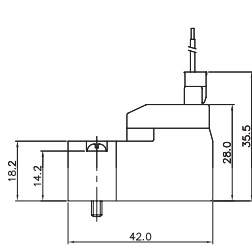
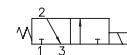

YSV20-DP-SL-***
Normally Closed

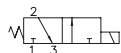

Manifold Block Ordering Code

YMF 20		-	2
Symbol	Manifold Station		
YMF20	3 Way	02	2-Station
		04	4-Station
		06	6-Station
		08	8-Station
		10	10-Station
		12	12-Station
		14	14-Station

Blanking Plate Ordering Code

YMF20-BLK

Blanking Plate.
(Material: STS304)

Manifold Plate.
(Material: STS304)

Manifold Gasket.
(Material: NBR)

YMF20 MANIFOLD BLOCK

(YSV20 Solenoid Valve Use)

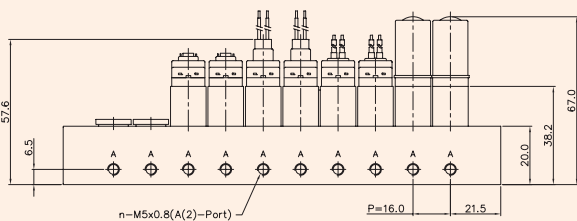
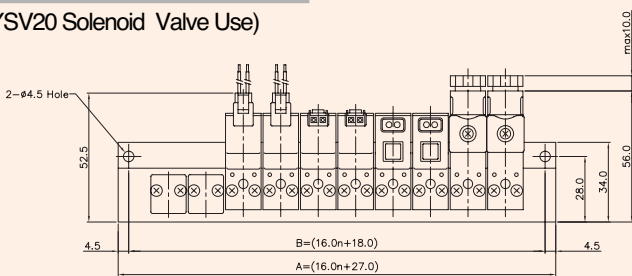

3-PORT MANIFOLD BLOCK DIMENSION							
ITEM	2	4	6	8	10	12	14
B	50.0	82.0	114.0	146.0	178.0	210.0	242.0
A	59.0	91.0	123.0	155.0	187.0	219.0	251.0

